



DOSATRON[®]

WATER POWERED DOSING TECHNOLOGY



AUTOMATE YOUR NUTRIENT DELIVERY

The Nutrient Delivery System is an assembly of high-quality dosers connected with easy-to-configure kits. The system thrives anywhere from greenhouse environments to outdoors, allowing installation in any application.

The Nutrient Delivery System features Water-Powered Dosatron Dosers whose proven technology of reliability and accuracy has been upheld for over 40 years.

With total dilution control in mind, customizing the system is easy, based on your personal nutrient program. It provides increased quality, and makes the process of blending and dispensing nutrients easier and more accurate.

- Automate the Nutrient Delivery process to reduce human error
- Decrease labor cost and increase profits
- Repeatable performance with a simple interface
- No Venturi tips, no clogs
- Modular kit concept allows for a customized system to fit every application
- Outstanding customer service and technical support

The Heart of Our Systems



Dosatron Dosers

Water-Powered

Water-powered, no electricity is needed

Easy to adjust, just turn the dial to set the necessary dosage rate

Volumetric proportioning, ensuring the mixture remains consistent, regardless of variations in pressure and flow

Piston technology, mixing the water flowing through the doser with the concentrate for a blended solution



Etatron Pumps

Electric

Energy saving, microprocessor metering pump

Provides consistent dosing

Standard PVDF solenoid head

Compact design

IP65 acid resistant housing

Programmable dosing, automatically adjusts the frequency of the dose based on the flow rate

The Nutrient Delivery System Series

Perfect for: Nutrients • Fertilizers • Insecticides • Fungicides
Acids • Caustics • Wetting Agents • Disinfectants • Cleaners

Lo-Flo Series

- Water-Powered - 3/4 inch System Kits
(Flow range of 2 - 10 GPM)
- Micro-Doser System - 3/4 inch Kit
(Flow range of 0.5 - 20 GPM)

Hi-Flo Series

- Water-Powered - 1 1/2 inch System Kits
(Flow range of 5 - 40 GPM)
- Micro-Doser System - 1 1/2 inch Kit
(Flow range of 5 - 60 GPM)

Mega-Flo Series

Flow range of 5 - 400 GPM

- Dosatron D20S - 100 GPM
2 inch NPT
- Dosatron D132 - 132 GPM
3 inch NPT
- Dosatron D400 - 400 GPM
4 inch Flange



We thought it through!

HOW IT WORKS

Water-Powered Nutrient Delivery System

Applications: Drip Irrigation • Vertical Farming • Overhead Irrigation
Grow Towers • Octo-Bubbler System • Batch Tank Fill

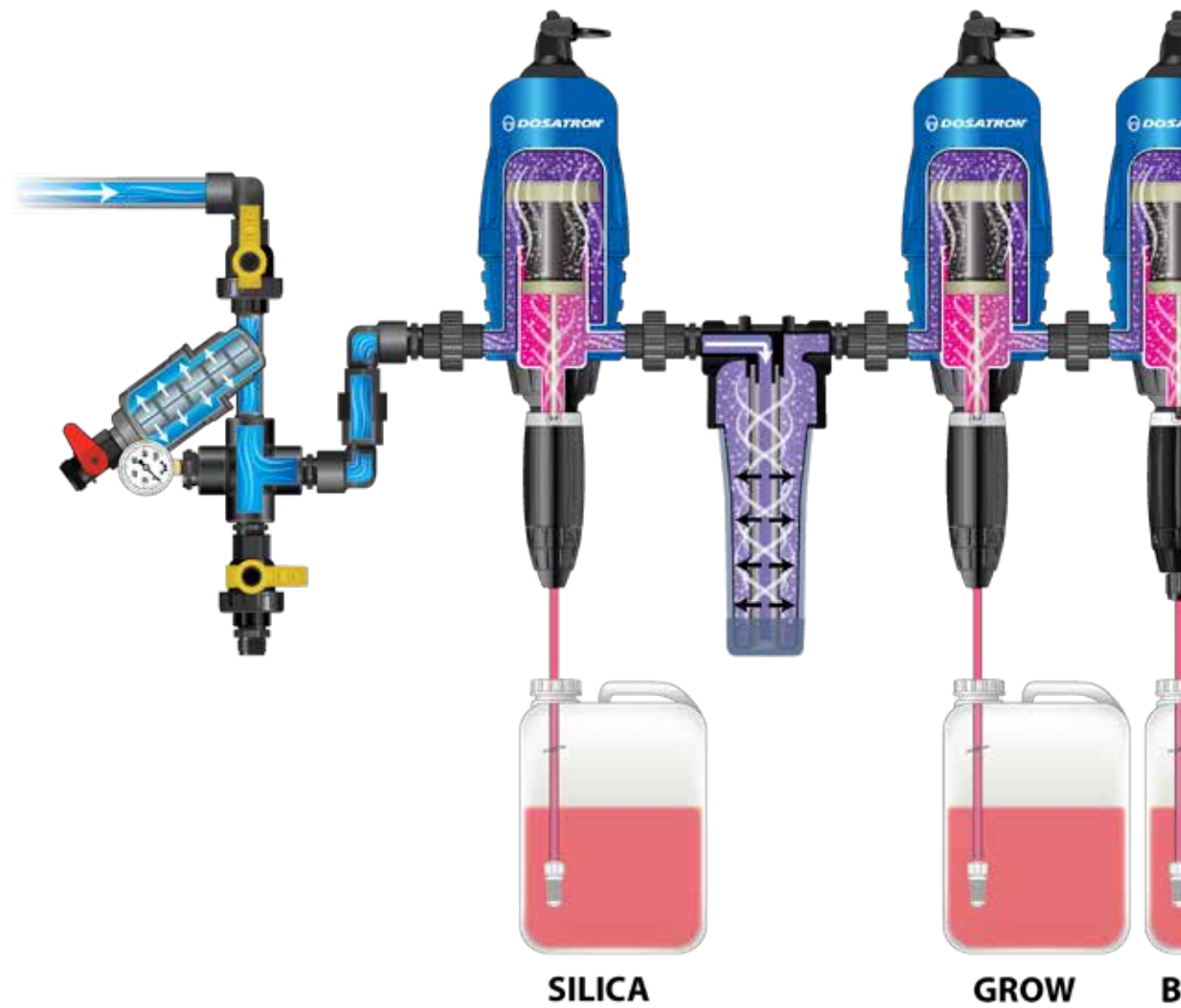

- Water-powered, energy saving
- Customizable and expandable by adding more dosers
- Works with various substrates and irrigation methods
- Easily doses different nutrients, additives, or supplements, plus a pH adjuster for a perfect, well-blended solution
- Makes the time draining practice of “measure and pour” a thing of the past, saving you time and money

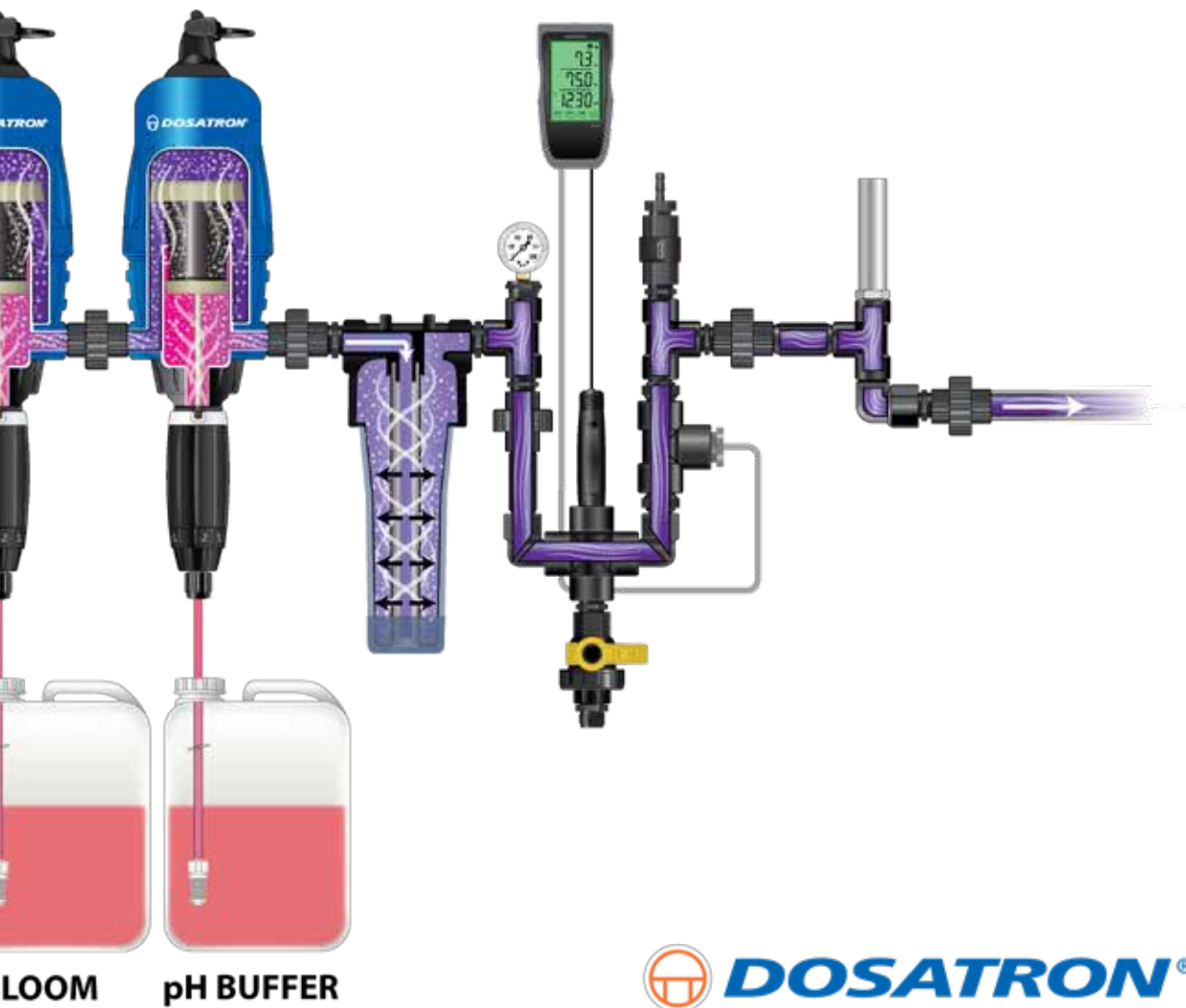

 **DOSATRON**[®]
WATER POWERED DOSING TECHNOLOGY

LO-FLO SERIES

3/4 inch Water-Powered Nutrient Delivery System

How to configure your Lo-Flo System with Dosatron and the customizable Nutrient Delivery System Kits



3/4" DAB Starter Kit

This kit includes all the parts you need for the inlet of your Nutrient Delivery System.

Item #: HYKSTART-DAB

For high pressure situations use the Standard Starter Kit - Item #: HYKSTART



1



3/4" Mixing Chamber Kit

This kit will enhance the blending as the solution passes through. It's a must have for silicates!

Item #: HYKMC34

**Mixing Chamber sleeve Sunshade sold separately
Part #: MC34-SHADE

2



If you have any questions
CHAT at www.dosatron.com

NOTE: Installation illustrations are for informational purposes only.

It is easy

1. Determine the number of products being dosed and their application rate/ranges
2. Determine the flow requirements of the irrigation system that will be fed by the Nutrient Delivery System
3. Choose the appropriate Dosatron dosers by referring to the **Dosatron Doser Selection Chart**
4. Pick the Water-Powered Nutrient Delivery Kits that you need from the graphic below



For more information, call 1-800-523-8499 or visit dosatronusa.com

This document is to be used as a reference guide only

*Multiple Monitor options available

HI-FLO SERIES

1 1/2 inch Water-Powered Nutrient Delivery System

How to configure your Hi-Flo System with Dosatron and the customizable Nutrient Delivery System Kits

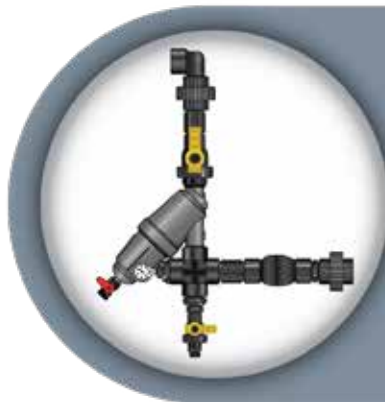

1 1/2" Starter Kit

This kit includes all the parts you need for the inlet of your Nutrient Delivery System.

Item #: HYKSTART150

1



1 1/2" Mixing Chamber Kit

This kit will enhance the blending as the solution passes through. It's a must have for silicates!

Item #: HYKMC150

2



If you have any questions
CHAT at www.dosatron.com

NOTE: Installation illustrations are for informational purposes only.

It is easy

1. Determine the number of products being dosed and their application rate/ranges
2. Determine the flow requirements of the irrigation system that will be fed by the Nutrient Delivery System
3. Choose the appropriate Dosatron dosers by referring to the **Dosatron Doser Selection Chart**
4. Pick the Water-Powered Nutrient Delivery System Kits that you need from the graphic below

3

1 1/2" Water Hammer Arrestor Kit

This kit protects the system from water hammer, keeping the system clicking for years to come.

Item #: WHA150-SS-KIT



4

1 1/2" Monitor Kit

The in-line nutrient monitor measures and displays the well blended outgoing solution providing peace of mind.

Item #: HYKMON150

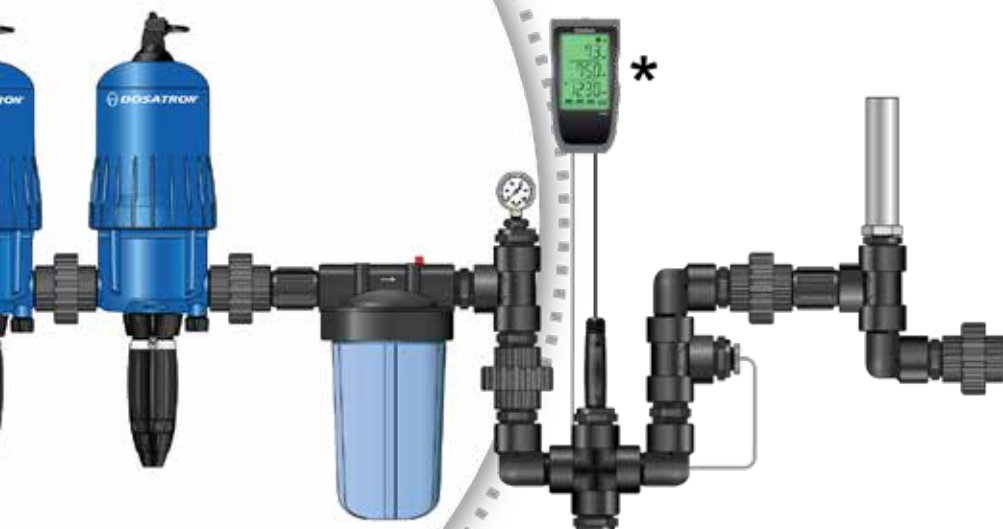

DOSATRON
PRECISION DOSING TECHNOLOGY

For more information, call 1-800-523-8499 or visit dosatronusa.com

This document is to be used as a reference guide only

*Multiple Monitor options available





REFERENCE CHARTS

Use these charts when selecting the proper Dosatron Water-Powered Dosers to be used with your Nutrient Delivery System.

For more information or for any help selecting your dosers and kits that better suit your application, call **1-800-523-8499**, or CHAT with us @ www.dosatronusa.com.



Dosatron Doser Selection Chart

For use with **Lo-Flo Series** Water-Powered Nutrient Delivery System

Lo-Flo Series Flow Range: 2 to 10 GPM				
MODEL	D25RE09VFBPHY (*D25RE09VFBPHY-M)	D14MZ3000VFBPHY (*D14MZ3000VFBPHY-M)	D14MZ2VFBPHY	D14MZ10VFBPHY
INJECTION RANGE	4 to 34 mL/gal 0.1 to 0.9%	1.25 to 11 mL/gal 0.03 to 0.33%	7.5 to 75 mL/gal 0.2 to 2%	37.5 to 375 mL/gal 1 to 10%
MAX PRESSURE	85 PSI	85 PSI	85 PSI	85 PSI
CONNECTIONS	3/4" NPT	3/4" NPT	3/4" NPT	3/4" NPT

*Available with metric system scale.

For use with **Hi-Flo Series** Water-Powered Nutrient Delivery System

Hi-Flo Series Flow Range: 5 to 40 GPM			
MODEL	D40MZ3000BPVFHY	D40MZ2BPVFHY	D40MZ5BPVFHY
INJECTION RANGE	1.25 to 7.5 mL/gal 0.03 to 0.2%	7.5 to 75 mL/gal 0.2 to 2%	37.5 to 190 mL/gal 1 to 5%
MAX PRESSURE	116 PSI	116 PSI	116 PSI
CONNECTIONS	1 1/2" NPT	1 1/2" NPT	1 1/2" NPT

Dosatrons include: mounting bracket, suction hose, weighted strainer, one union*, and quick start guide. Please review the basic installation drawing for recommended accessories. MAXIMUM TEMPERATURE: 104 °F. *Each doser comes with a single union to connect to the next doser or kit

MICRO-DOSER SYSTEMS

Lo-Flo and Hi-Flo Series Nutrient Delivery System

The Etatron eOne Micro-Doser can accurately inject super-concentrated products and can be integrated into an existing fertigation system. The Micro-Doser is able to hit target rates of many high-value products on the market

These kits can work in combination with a Dosatron Water-Powered Nutrient Delivery System, or as a stand-alone solution, to provide the ultimate in reliability and functionality in one system

- Applications include dosing acids (pH down), caustics (pH up), plant health additives, and water treatment products
- Ability to micro-dose down to 0.1 mL per gallon, depending on the flow rate

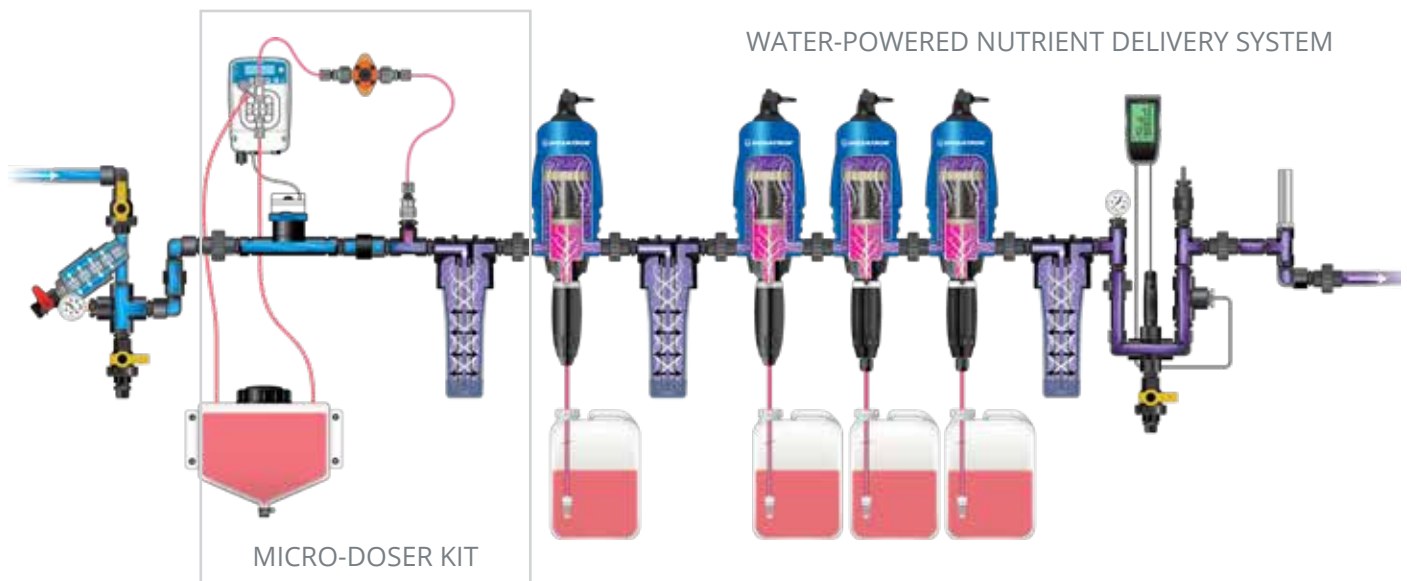

	Item Number	Description
	MDE0110MF.75KIT	Lo-Flo Micro-Doser Kit Etatron eOne Kit w/ Water Meter & Pressure Relief Valve Connections - 3/4" NPT
MDE0110MF1.5KIT	Hi-Flo Micro-Doser Kit Etatron eOne Kit w/ Water Meter & Pressure Relief Valve Connections - 1 1/2" NPT	

NOTE: Installation illustrations are to be used as a reference guide only

MEGA-FLO SERIES

Water-Powered Injectors

Dosatron's Mega-Flo Series
Fertilizer and Chemical Injectors

D20S

100 GPM

Non-electric, water-powered

Volumetric and proportional

Perfect for: Fertilizers • Insecticides • Fungicides • Algaecides
Nutrients • Disinfectants • Compost Tea • Organics • Acids



Dilution Range	1:500 to 1:50 (.2% to 2%)
Water Flow Range	5 to 100 GPM
Operating Pressure Range	2 to 120 PSI
Available Housing Materials	Aluminum (Standard Blue)
Seal Materials	Viton®
Dimensions	55" x 15" (with legs); 42" x 15" (no legs)
Weight	47 lbs
Connection Size	2" NPT
Maximum Temperature	104 °F
Recommended Accessories	200 mesh filter, check valve

Unit includes: Set of legs, manual bypass, 6 ft clear suction tube, strainer, vacuum breaker and operating manual. MAXIMUM TEMPERATURE: 104°F

MEGA-FLO SERIES

Water-Powered Injectors

Dosatron's Mega-Flo Series
Fertilizer and Chemical Injectors

D132

132 GPM

Non-electric, water-powered

Volumetric and proportional

Externally adjustable injection rate

Built-in bypass

3 inch NPT

Low injection rate model (1:30,000) is perfect
for direct injection of water treatment chemicals

Perfect for: Fertilizers • Insecticides • Fungicides • Algicides
Chlorine • Disinfectants • Water Treatment • Caustics • Acids



MODEL	D132MZ30000	D132MZ5000	D132MZ1
MAX. FLOW	132 GPM	132 GPM	132 GPM
MIN. FLOW	35.2 GPM	35.2 GPM	35.2 GPM
INJECTION PERCENTS	0.003% to 0.03%	0.02% to 0.2%	0.1% to 1%
INJECTION RATIO	1:30,000 to 1:3,000	1:5,000 to 1:500	1:1,000 to 1:100
PRESSURE RANGE	7 - 87 PSI	7 - 87 PSI	7 - 87 PSI
CONNECTIONS	3" NPT	3" NPT	3" NPT

Unit includes: suction hose, weighted strainer, and quick start guide. MAXIMUM TEMPERATURE: 104°F

MEGA-FLO SERIES

Water-Powered Injectors

Dosatron's Mega-Flo Series
Fertilizer and Chemical Injectors

D400

400 GPM

Non-electric, water-powered

Volumetric and proportional

Externally adjustable injection rate

Built-in bypass

4 inch flange

Engineered Diversion Technology

Perfect for: Fertilizers • Insecticides • Fungicides • Algaecides

Nutrients • Disinfectants • Compost Tea • Organics • Acids



MODEL	D400MZ02	D400MZ05	D400MZ30000
MAX. FLOW	400 GPM	400 GPM	400 GPM
MIN. FLOW	110 GPM	110 GPM	110 GPM
INJECTION PERCENTS	0.02 to 0.2%	0.1 to 0.5%	0.003 to 0.0125%
INJECTION RATIO	1:5,000 to 1:500	1:1,000 to 1:200	1:30,000 to 1:8,000
PRESSURE RANGE	7.25 to 116 PSI	7.25 to 116 PSI	7.25 to 116 PSI
CONNECTIONS	4" Flange	4" Flange	4" Flange
OPTIONAL ACCESSORY	Flange Kit (Item #: D400FL-KIT) 4" female NPT	Flange Kit (Item #: D400FL-KIT) 4" female NPT	Flange Kit (Item #: D400FL-KIT) 4" female NPT

Unit includes: Built-in bypass, externally adjustable injection rate. MAXIMUM TEMPERATURE 104°F

MEGA-FLO SERIES

Water-Powered D400 Installation Options

- **PARALLEL INSTALLATION**

Allows for water flow rates up to 1,200 GPM

D400 x 3 - 1200 GPM

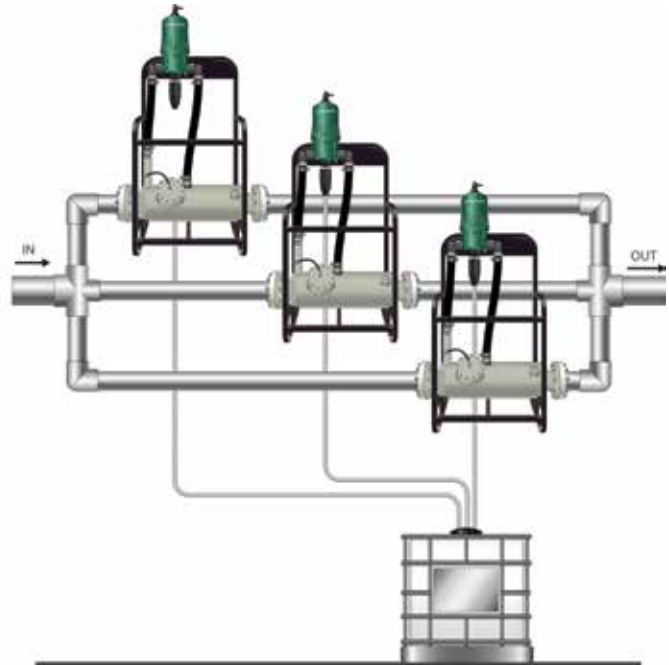

- **SERIES INSTALLATION**

Allows for simultaneous dosing of three different solutions at different dilution rates

D400 x 3 - 400 GPM

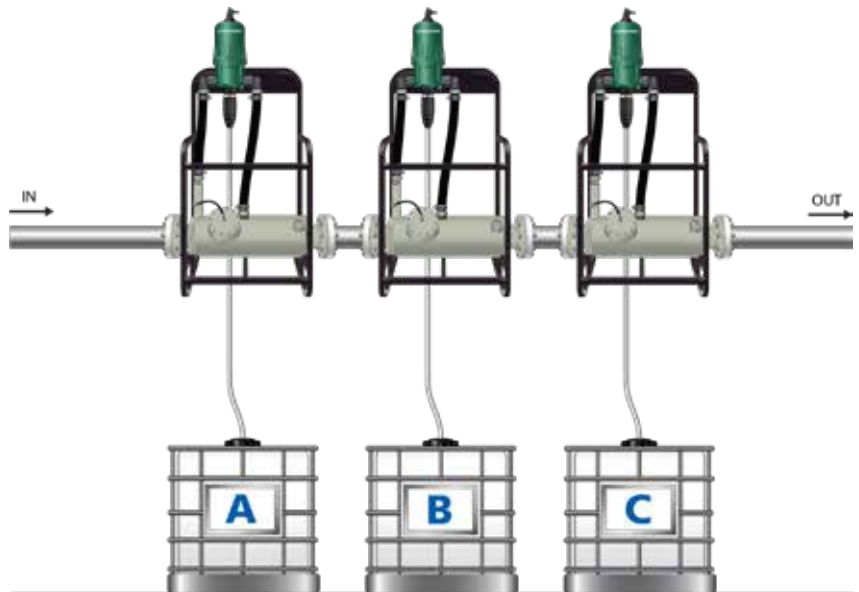

NOTE:

Installation illustrations are to be used as a reference guide only.

Please meet all state and local requirements for backflow prevention.



Dosatron International, LLC. • 2090 Sunnydale Blvd. • Clearwater, FL 33765 • 1-727-443-5404
1-800-523-8499 • www.dosatronusa.com