



**Part PJDI139MINI:
D14MZ3000 - 14 GPM
D8RE3000 - 40 GPM
Mini Maintenance Kit**

This kit contains:



(1) PJDI063	Upper check valve assembly
(1) JDI148	Plunger seal
(1) Silicone	DOSA-LUBE



Vea el reverso para instrucciones en Español.

2090 Sunnydale Blvd.
Clearwater, FL 33765
1-800-523-8499
1-727-443-5404
www.dosatronusa.com



Kit Contents:

PJDI063:
Upper check valve assembly



JDI148:
Plunger seal



DOSA-LUBE:
2.5 grams silicone



Use **Dosa-Lube** on specified parts only.

STOP CAUTION: Parts may contain concentrated chemicals. The use of Proper Protective Equipment is recommended when performing maintenance.

! To remove seal easily without tools, squeeze it on either side to raise the seal, then slide it over the groove. Using sharp tools could damage the plunger.

Instructions

(Parts included in kit noted in blue)

1. Unscrew hose nut (PDI934). Unscrew injection stem assembly nut (PDI702) and pull down on stem to detach from body of unit.

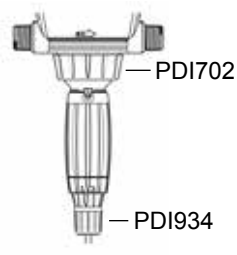

2. Unscrew check valve nut (PDI734) and pull out check valve assembly (PJDI140). It should come out in one piece, if not, be sure to remove the barb.

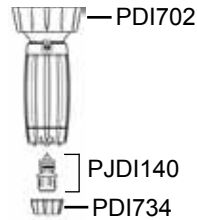

3. Pull out upper check valve (PJDI063) and discard.

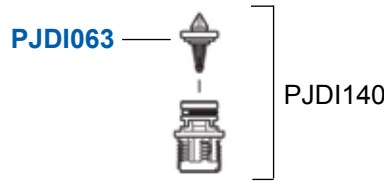

4. Carefully remove old plunger seal (JDI148) and replace with the new one.

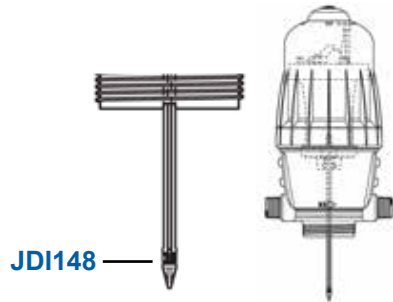

5. Place upper check valve (PJDI063) on check valve barb making sure to insert spring portion down. Insert the check valve (PJDI140) at the bottom of the white stem, the 4 white keys on the check valve should seat next to the 4 keys on the bottom of the stem. Screw check valve nut (PDI734) back on.

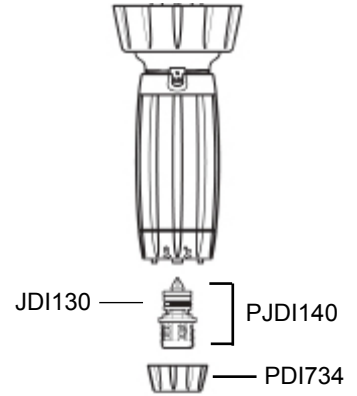

Rub small amount of **Dosa-Lube** on the check valve barb o-ring (JDI130).

6. Push complete injection stem assembly in position at the bottom of the blue body, making sure desired scale is facing front of injector. Keys at the top of the black sleeve should slide into the slots at the bottom of the body. Slide injection sleeve nut (PDI702) up the sleeve and screw back on.

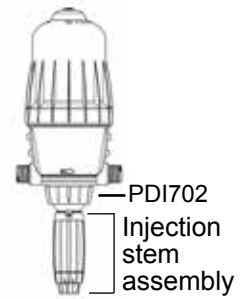

7. Insert hose back onto the bottom of the check valve barb with compression fitting in (PJDI140). Screw hose nut (PDI934) back on.

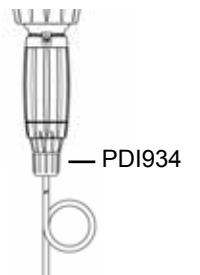

! To ensure hose is air-tight, you may choose to carefully cut the top of hose before reinserting.



**Parte PJD139MINI:
D14MZ3000 - 14 GPM
D8RE3000 - 40 GPM**
Mini Kit de Mantenimiento

Este kit contiene:



(1) PJD1063	Ensamble superior de la válvula cheque
1) JDI148	Sello del émbolo
(1) Silicona	DOSA-LUBE



See the back for English instructions.

2090 Sunnydale Blvd.
Clearwater, FL 33765
1-800-523-8499
1-727-443-5404
www.dosatronusa.com

Instrucciones

(Partes en color azul incluidas en el kit)

- Desatornille la tuerca de la manguera (PDI934). Desatornille la tuerca del montaje de inyección (PDI702) y remuevalo de la unidad.

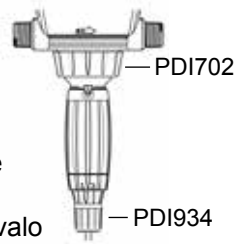

- Desatornille la tuerca de la válvula cheque (PDI734) y jale la válvula cheque (PJD1140) para removerla. Si no sale entera, asegúrese de remover la lengüeta.

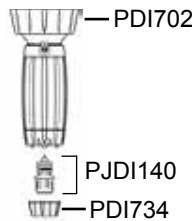

- Remueva el ensamble superior de la válvula cheque (PJD1063) y deséchelo.

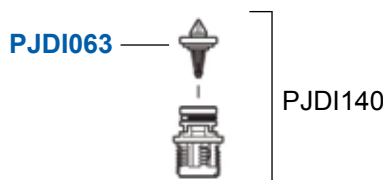

- Cuidadosamente remueva el sello del émbolo (JDI148) y replacelo con el nuevo.

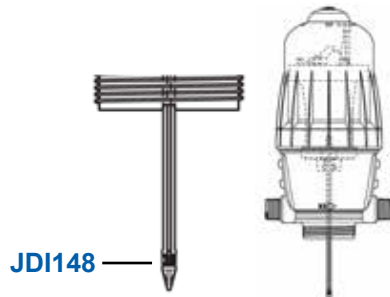

- Coloque la parte superior de la válvula cheque (PJD1063) en la lengüeta asegurándose de insertar la porción del resorte hacia abajo. Inserte la válvula cheque (PJD1140) por la parte inferior de la barra blanca, los cuatro dientes blancos en la válvula deben encajar al lado de los dientes en la parte inferior de la barra blanca. Atornille la tuerca de la válvula cheque (PDI734) de nuevo en su lugar.

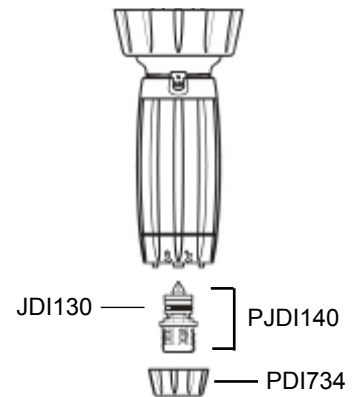

Coloque un poco de **Dosa-Lube** en el o-ring (JDI130) de la lengüeta de la válvula cheque.

- Sujete el vástago de inyección a la parte inferior de la unidad, asegúrese que la escala deseada se muestra en el frente del inyector. Las llaves en la parte superior de la manga negra deben encajar en las muescas en la parte inferior del cuerpo de la unidad. Atornille de nuevo la tuerca de la manga de inyección (PDI702) a la unidad.

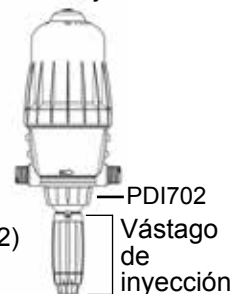

- Sujete la manguera a la lengüeta de la válvula cheque y atornille la tuerca de la manguera (PDI934).

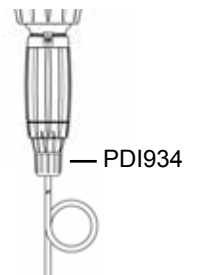

! Para asegurarse que haya una succión adecuada, usted puede cortar con cuidado la punta de la manguera en línea recta.

Contenido del Kit:

PJD1063:
Ensamble superior de la válvula cheque



JDI148: Sello del émbolo



DOSA-LUBE:
2.5 gr silicona



Use **Dosa-Lube** únicamente sobre las partes indicadas.



PRECAUCIÓN: Las partes pueden contener químicos concentrados. El uso de Equipo de Protección Adecuado es recomendado cuando se efectúa el mantenimiento.



Para remover el sello fácilmente sin el uso de herramientas, apriete a ambos lados del sello, y deslícelo sobre la ranura. El uso de herramientas afiladas podría dañar el émbolo.