



Part PJDI135: D14MZ520 - 9 GPM Injection Seal Kit

This kit contains:

(1) JDI122	Stem o-ring
(2) JDI100	Sleeve o-ring
(1) PJDI136	Plunger valve assembly
(1) PJDI139	Plunger seal
(1) J052	Side-inject o-ring
(1) J802	Side-inject seal
(1) PJDI118	Check valve assembly
(1) JDI013	Check valve top seal
(1) Various	Side Inject Check valve assembly
(2) JDI108	Side-inject connection o-ring



2090 Sunnydale Blvd.
Clearwater, FL 33765
800-523-8499 • 727-443-5404
www.dosatronusa.com

Kit Contents:

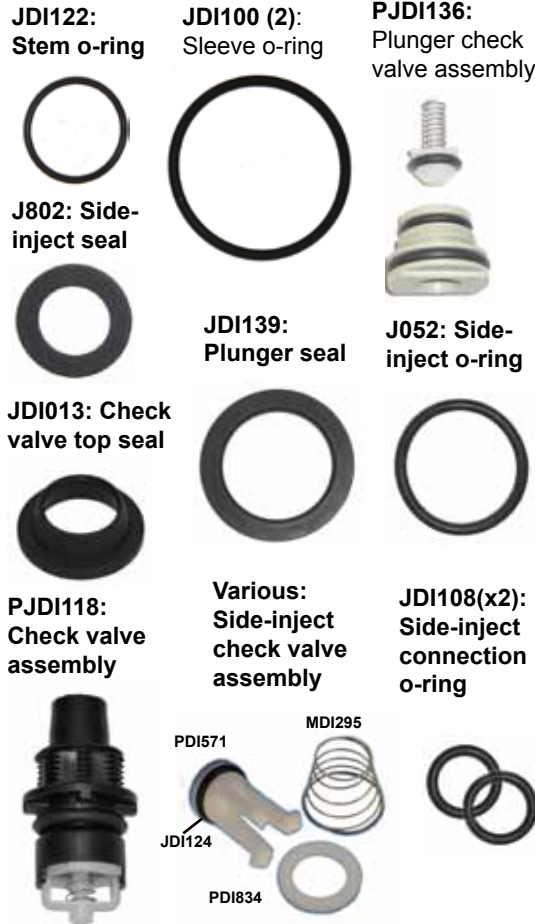

Instructions

(Parts included in kit noted in blue)

1. Remove side-inject tubing. Unscrew nut (PDI702) and pull down on stem assembly (CDDI078) to detach.

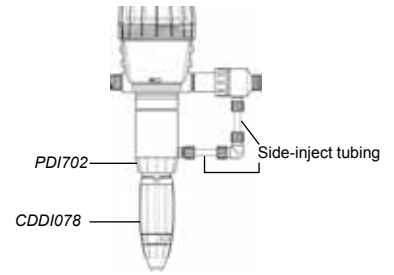

2. Remove hose nut (PDI748), check valve nut (PDI747), lock nut (PDI746), lock ring (PDI751) and adjusting nut (PPDI037). Remove check valve assembly (**PJDI118**).

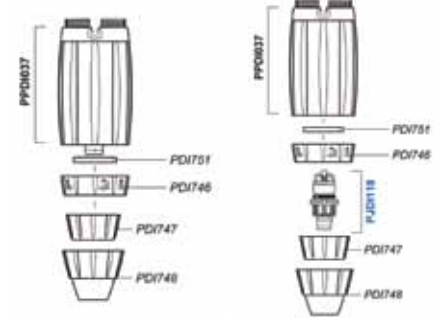

3. Push injection stem (PDI743) up from bottom of the sleeve (PDI844). Replace o-ring (**JDI122**) and slide stem back down into the sleeve, making sure to align long groove in stem with key in sleeve.

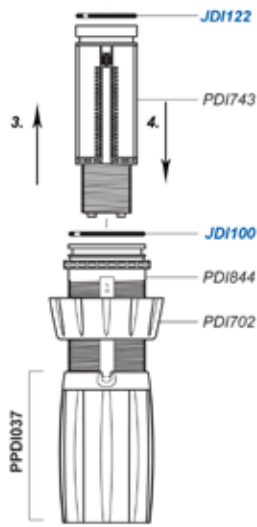

5. Reinstall lock ring (PDI751), making sure to align the molded keys with the grooves on the white stem. Reinstall the lock nut (PDI746). Replace check valve assembly (**PJDI118**) and reinstall check valve nut (PDI747) and hose nut (PDI748). Set completed stem assembly aside.

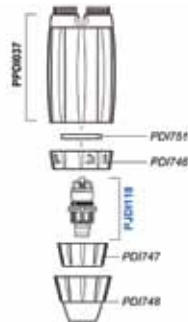

7. Hold motor (PCDI030) and turn rod (PDI839) one-quarter turn counter-clockwise. Pull down to disengage.

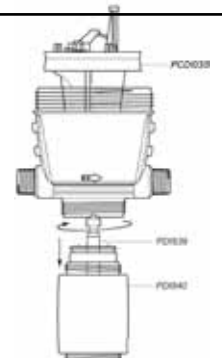

4. Replace sleeve o-ring (**JDI100**). Slide nut (PDI702) back up sleeve (PDI844). Align adjusting nut (PPDI037) with graduated scale and screw three-quarters of the way up.

6. A. Remove bell housing (PDI685) and set aside, exposing unit motor.

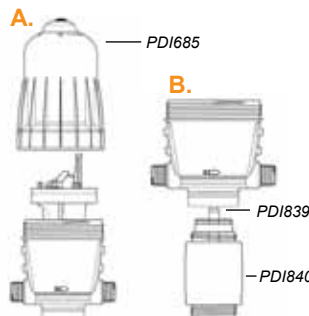

- B. Unscrew cylinder (PDI840) from difuser nut (PDI840) and pull down until top of rod (PDI839) is exposed.

8. Remove nut (PDI705) and seal (**JDI013**) from top of side inject cylinder (PDI840). Remove plunger assembly from cylinder and remove and replace o-ring (JDI100). Remove plunger seal (**JDI139**) from assembly and replace. Remove beige nut (PDI843) from bottom of plunger assembly and remove check valve assembly (**PJDI136**). Insert new plunger check valve assembly; tighten clockwise. Reinsert plunger assembly into side inject cylinder. Install (**JDI013**) over plunger rod and reinstall nut (PDI705).

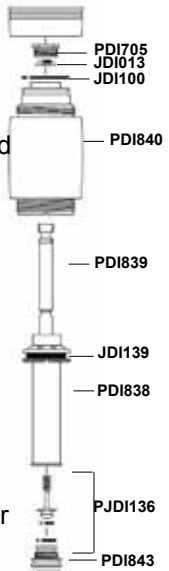

Turn over to continue

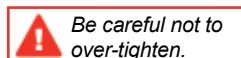

9. Reattach rod (PDI839) to motor by inserting rod into slot in motor and turning one-quarter turn clockwise.

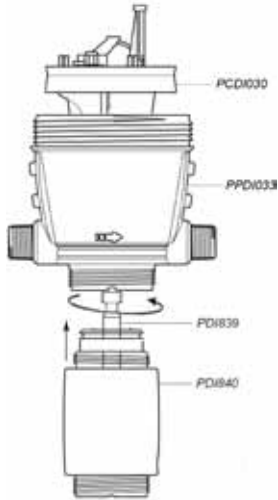

10. Push side inject cylinder (PDI840) up and screw into difuser nut (PDI841), making sure the side-inject port lines up under the outlet port on the lower housing.

11. Reattach stem assembly (CCDI078) to cylinder (PDI840) by lining up molded keys on the stem with the notches on the threaded portion of the cylinder and pushing firmly up. Screw nut (PDI702) back on.

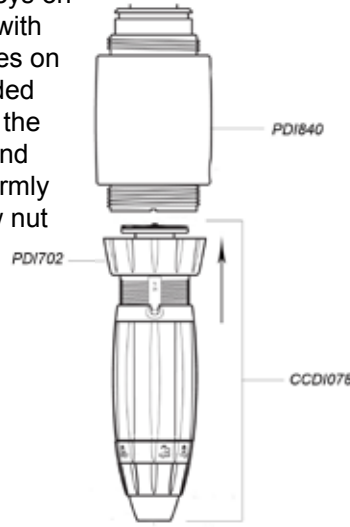

12. Reinstall bell housing (PDI685).

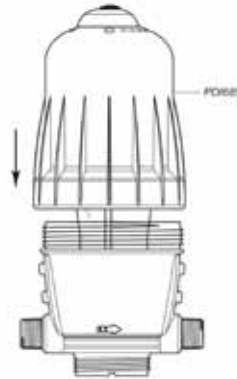

13. From lower part of side-inject cylinder (PDI840), remove connector (PJ149), replace o-ring (JDI108), then reinstall connector.

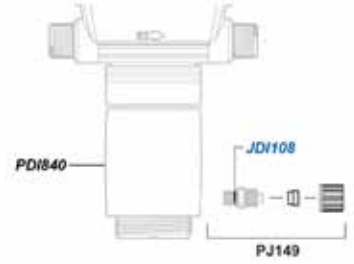

14. Unscrew side-inject assembly (PJD1132) from the outlet port on the lower housing (PPDI033).

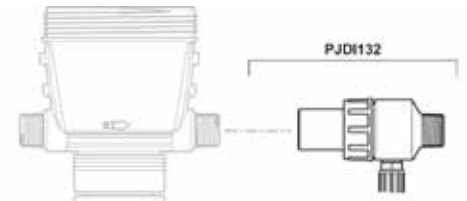

15. Unscrew connection (PJD1134) from the bottom of the side-inject assembly (PJD1132), replace o-ring (JDI108) and reinstall connector.

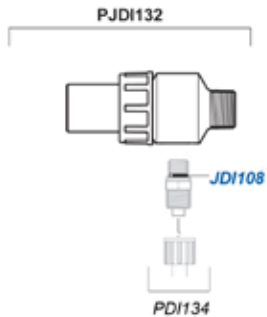

17. Remove plastic flat washer (PDI834) and spring (MDI295) by squeezing tines together and push side inject check valve through cylinder and outlet port with a pencil. Remove o-ring (J052) and replace.

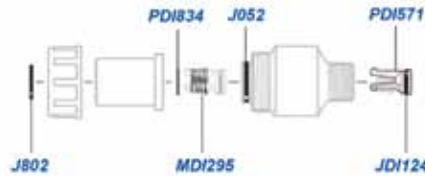

19. Line up side-inject assembly (PJD1132) with outlet on lower housing (PPDI033) and screw back onto threads, making sure the side inject assembly port lines up with the side inject cylinder port above the stem.

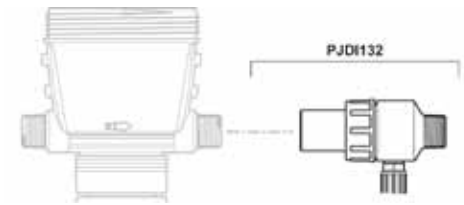

16. Unscrew nut (PDI901) and pull off side-inject threaded connector (PDI902FV) to expose spring-loaded check valve parts.

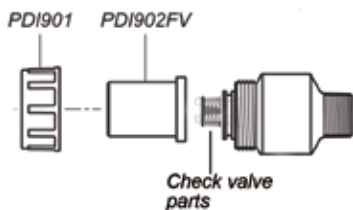

18. Install new side inject check valve by pushing side inject check valve tines into outlet side of port first, then push with a pencil from behind until tines stick out opposite side. Install new check valve spring (MDI295) then install flat plastic washer (PDI834). Reinstall threaded connector (PDI902FV) and nut (PDI901). Remove and replace flat rubber washer (J802) on inlet side of side inject assembly.

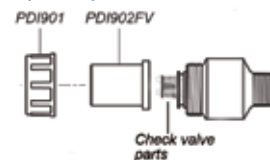

20. Reconnect all tubing and nuts.

