



**MODEL
DSA 200 RE**

**MANUEL D'UTILISATION
BEDIENUNGSANLEITUNG
MANUEL DE UTILIZACIÓN
OPERATING INSTRUCTIONS**

**NON ELECTRIC PROPORTIONAL
LIQUID DISPENSER
EXTERNAL ADJUSTMENT
0,2% TO 2%**

**MODEL
DSA 200 RE**

This document does not form a contractual engagement and is for information only. DSA reserves the right to modify its products at any time and without prior notice

**DSA - SIRET Bx 300 883 345 000 47
BP 7 - 33370 TRESSES - FRANCE**



THE DISPENSER DISCHARGES WATER BACK INTO THE STOCK SOLUTION

- The conical valve seal was installed upside down. ④
- The conical valve seal is not sealing: a small particle has adhered to the lip of the seal or the seal was damaged when dismantling the dispenser. ④
- The suction valve spring has not been reinserted (often lost when dismantling). ⑤

THE DISPENSER LEAKS (DOSING PART)

- The doser body seal is not sealing. The seal seat is scratched (a small scratch would be sufficient). The doser body must be changed. ⑦
- The sleeve seal is not sealing. The seal has been trapped or pinched when reassembling the dispenser and must be changed. ⑧

PROBLEMS DURING OPERATION

THE DISPENSER DISCHARGES WATER BACK INTO THE STOCK SOLUTION

- Observe paragraph 1 and 2 of chapter " The dispenser does not prime "
- The conical valve seal is dirty (precipitations, deposits) or worn. ④
- The suction valve spring is broken. ⑤

THE DISPENSER STOPS PRIMING

- The conical valve seal is dirty or worn. ④
- The suction valve spring is broken. ⑤
- The plunger seal is worn. ⑥

THE DISPENSER STOPS CLICKING

- Check if there is enough pressure (minimum 0.5 Bar).
- The motor piston is blocked.
- The dispenser must be sent to the after sales service.

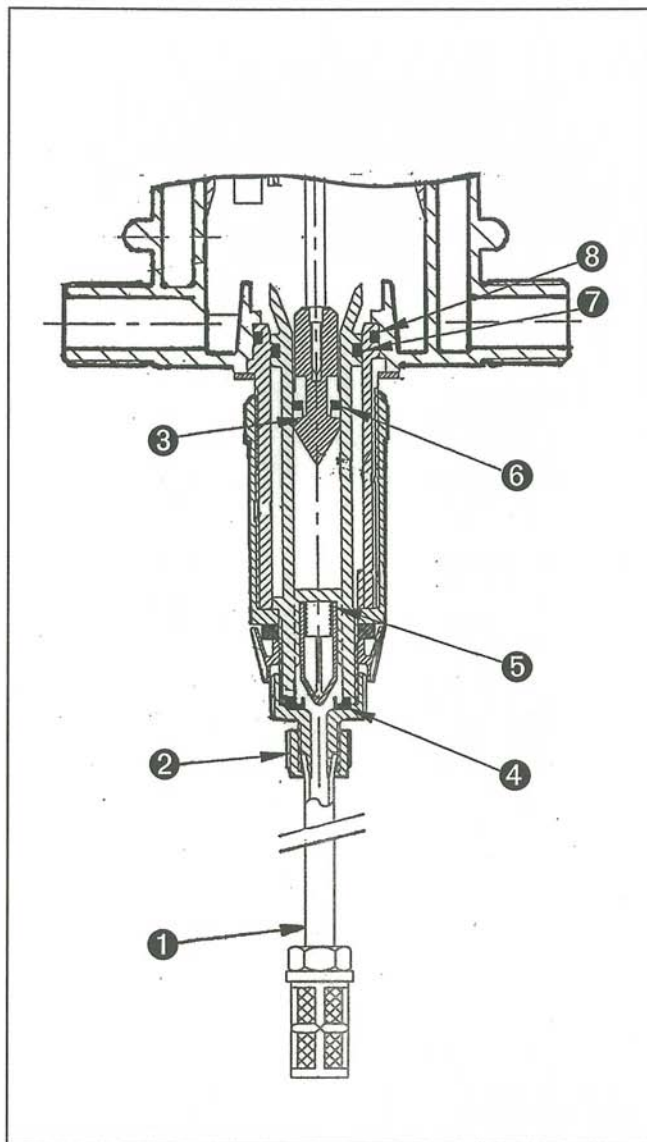

Before any dismantling of the dispenser it should be rinsed to eliminate all traces of concentrated products, turn off water and make sure the unit is not under pressure.



TECHNICAL SPECIFICATIONS

Dosage continuously variable:	from 0,2% to 2%
Flow:	from 20 l/h to 1500l/h
Pressure:	from 0,5 bar to 5 bars
Maximum fluid temperature:	45°C

The dispenser should be installed in a position protected from frost.

INSTALLATION

- Remove the red protective caps from the dispenser.



- Fit the dispenser into the support by slightly pulling apart the two sides to ensure that the 4 lugs of the dispenser body fit into the corresponding holes in the mounting bracket.
- Connect the dispenser to the water supply. Ensure that the water flows in the direction of the arrows on the dispenser body.

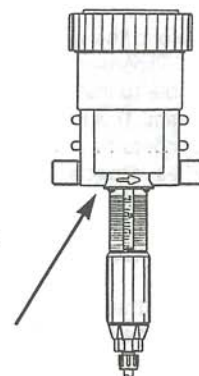

When connecting an installation either to the public water supply or to its own water source, you must respect the regulations in force concerning protection of the source i.e. backflow prevention, etc.

FITTING THE SUCTION TUBE

Package contents:

- a wall support
- a transparent suction tube (length 1.20m, internal \varnothing 6 mm)
- a suction strainer.

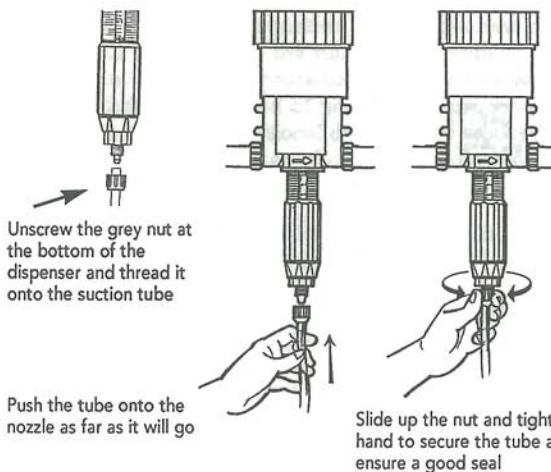

RECOMMENDATIONS FOR USE

To prolong the working life of the dispenser it is advisable to install a filter upstream. This is imperative if the water contains impurities or particles, especially if the water comes from a well. A 50 mesh (350 microns) filter is recommended.

Installing the unit on a by-pass enables clean water to be supplied without operating the dispenser.

The dispenser should be rinsed after each operation. The concentrate suction tube is simply plunged into a bucket of clean water and the dispenser operated for at least 5 minutes. This cleaning is indispensable when changing the product to be injected.

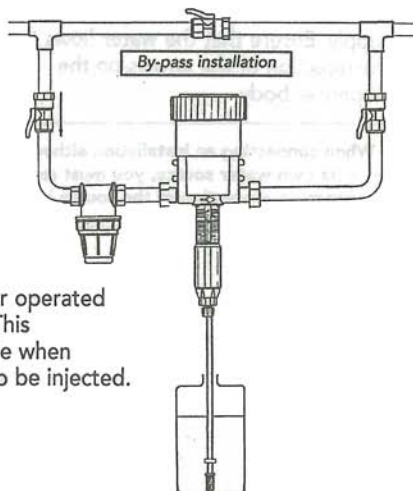
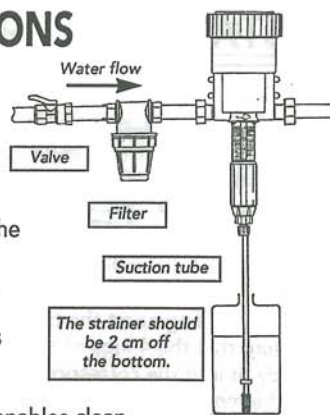

USING FOR THE FIRST TIME

- Plunge the suction tube and its strainer into the container of concentrate. The strainer should be at the very bottom to ensure that the concentrate is used up. If the product contains a sediment which could block the strainer, position the strainer at least 1 inch off the bottom of the concentrate container.
- Operate the unit until the product to be dosed is drawn up into the doser body (the product is visible through the plastic tube).
- The dispenser is self-priming and makes a characteristic "click-click" noise when working.

SETTING THE DOSAGE

- 1 - Loosen the conical locking ring
- 2 - Screw up the setting sleeve to increase the dosage or unscrew to decrease.
- 3 - Tighten the conical locking ring (without forcing)

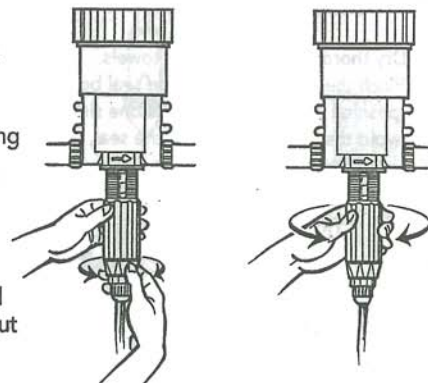

SERVICING-MAINTENANCE

Before carrying out any work, turn off the water supply upstream of the dispenser.

Never use metal tools. All the components are assembled manually. Never use excessive force.

The proportional dispenser should be rinsed regularly. We recommend that, each time the container of concentrate is changed, the suction tube and its strainer is plunged into a bucket of clean water and the unit is operated for 5 or 6 minutes.

After rinsing, transfer the suction tube to the new container and operate the unit until the tube is filled with concentrate. This rinsing procedure is imperative when changing the type or brand of product. Before any dismantling of the proportional dispenser it should be rinsed to eliminate all traces of concentrated products.

If the unit is not used over a long period, it should be rinsed and should not be held under pressure.

AFTER SALES SERVICE

Our After Sales Service ensures repairs within 48 hours (from reception at the factory to despatch)

The dispenser must be rinsed before being returned to the factory, especially in the case of dispensing dangerous or corrosive liquids.



Method of removing seals without tools.

Dry thoroughly using paper towels.

Pinch the component and the seal between finger and thumb (position 1) and push towards one side to deform the seal. To avoid the fingers sliding on the seal, place a piece of paper towel between the fingers and the seal.

Increase the deformation as shown in position 2.

Grip the part of the seal thus exposed and pull it out of its groove.

Position 1



Position 2



Refitting is done by hand.

It is very important that the seal should not be twisted once in place as this would impair its efficiency.

NEVER USE METAL TOOLS OR IMPLEMENTS

CHANGING THE DOSING ASSEMBLY SEALS

Pull apart the sides of the support to release the four lugs and lift out the dispenser

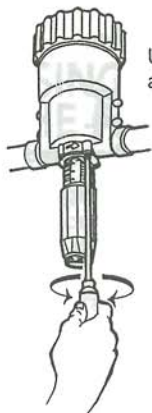

Unscrew the 4 screws holding the doser body assembly using a "Posidriv" screwdriver

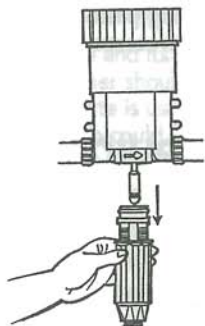

Remove the doser body assembly by pulling downwards as shown

NOTE. The dosing piston may not be visible. It may be inside the main body of the dispenser if the motor piston has stopped at the top of its stroke.

It can be pulled down with the help of a cord looped around it, or the black cover may be unscrewed from the motor body using a strap wrench and the motor piston pushed downwards.



CHANGE THE DOSING PISTON SEAL J009

J009

CHANGING THE 2 DOSER BODY SEALS

Unscrew the hose connector nozzle

WARNING, 3 components are released

- the valve spring
- the valve
- the valve seal

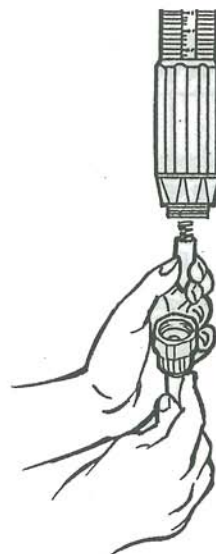

Unscrew the conical locking ring and remove the bearing washer

Turn the setting sleeve to 1,5%

Push the white doser body upwards as shown

CHANGE THE 2 SEALS J101 AND J024

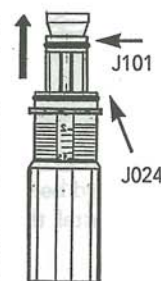

- Refit the white doser body into the black sleeve taking care to align the groove in the doser body with the lug on the inside of the black sleeve.
- Refit the bearing washer and the conical locking ring (hand tighten without forcing)



CHANGING THE VALVE SEAL

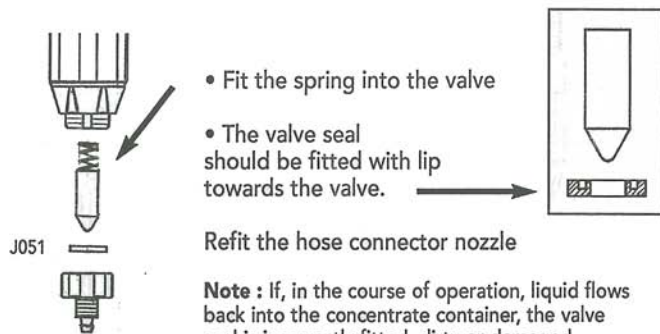

- Fit the doser body assembly into the motor body.

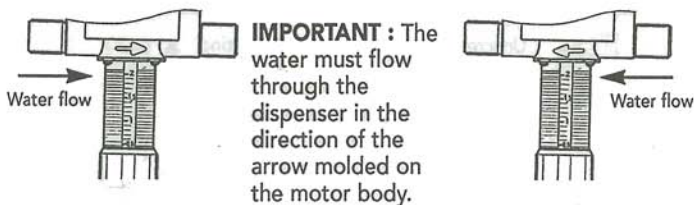

- Re install the dispenser and connect the water pipes.

GUARANTEE

Our products are guaranteed against all manufacturing and material defects for one year from the date of delivery.

The guarantee covers parts and labour and applies provided that the defects do not arise from abnormal use, faulty installation or maintenance, the use of inappropriate tools or external causes.



TROUBLESHOOTING GUIDE

Our dispensers have been designed to give complete satisfaction to our customers and to ensure maximum reliability.

Before leaving the assembly shop, each dispenser is tested on a test bench and leaves our warehouse in perfect operational condition.

The user, however, might come across 2 different kinds of problems:

- problems after dismantling or maintenance (the most usual)
- problems during operation

PROBLEMS AFTER DISMANTLING

STARTING THE DISPENSER

During its operation the dispenser makes a characteristic «clac clac» noise. If it does not, check that the direction of the water flow through the dispenser is correct (as indicated by an arrow on the pump body).

THE DISPENSER DOES NOT PRIME

- The additive in the suction tube is not brought up.
- Check that the suction hose and its strainer are plunged into the liquid to be dosed. ①
- Ensure that there is no possibility of air being sucked in between suction hose and dispenser. ②
- The plunger seal seat is damaged by a tool (a small scratch would be sufficient). The piston plunger must be changed. ③



Techniques de dosage des liquides

DSA développe, fabrique et distribue des systèmes de dosage de liquides qui permettent d'injecter et de mélanger en continu un concentré liquide ou soluble dans de l'eau.

Dosierteknik für flüssige Medien

DSA entwickelt, produziert und vertreibt Dosiersysteme für kontinuierliches Dosieren und gleichzeitiges Mischen von flüssigen oder löslichen Konzentraten mit Wasser.

Liquid proportioning technology

DSA develops, manufactures and markets liquid proportioning systems that allow any liquid or soluble concentrate to be injected and mixed continuously into water.

Técnicas de dosificación de líquidos

DSA desarrolla, fabrica y distribuye sistemas de dosificación de líquidos que permiten inyectar y mezclar en continuo un concentrado líquido o soluble en el agua.



DSA

Z.I. - B.P. 7
33370 TRESSES - BORDEAUX
FRANCE
Tél. 33 (0)5 57 97 10 70
Fax 33 (0)5 57 97 10 85
e.mail dsa@calvacom.fr

DSA - S.A. AU CAPITAL DE 300 000 F
SIRET BORDEAUX 300 883 345 00047
NAF 291 C
CODE TVA / VAT : FR 57 300 883 345